

Kitchen Faucet
6770-97-80S1

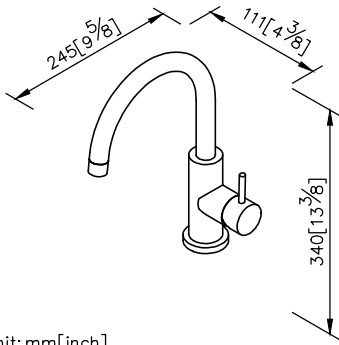

unit: mm[inch]

1. Stainless Steel material has character of acid-resisting, heat-resistant and erode-resisting and surface with brushed finish could increase durability.
2. Swiveling spout has passed up to 50,000 turns test.
3. Ceramic valve with CERAMTEC ceramic disc / (Germany)
4. Handle can be moved up to 25° to adjust water flow from closed position, hot and cold water control by swinging handle 45°.
5. Stainless steel braided hose with SANTOPRENE tube (meets NSF approval), can be stood 15Kg/cm2 water pressure and 120°C heat.
6. Stainless steel braided hose with M10 × 1.0mm (Male thread connect to faucet body) and 1/2"-14NPSM (Female thread connect to water supplier system).
7. Aerator with removable flow restrictor (2.2 GPM max.).

