

INSTALLATION GUIDE

TIP-TOUCH LAVATORY FAUCET W/MIXING VALVE

按壓式枱面龍頭安裝說明(冷熱混合)

PATENT NUMBER:

專利號碼

001018899-0001

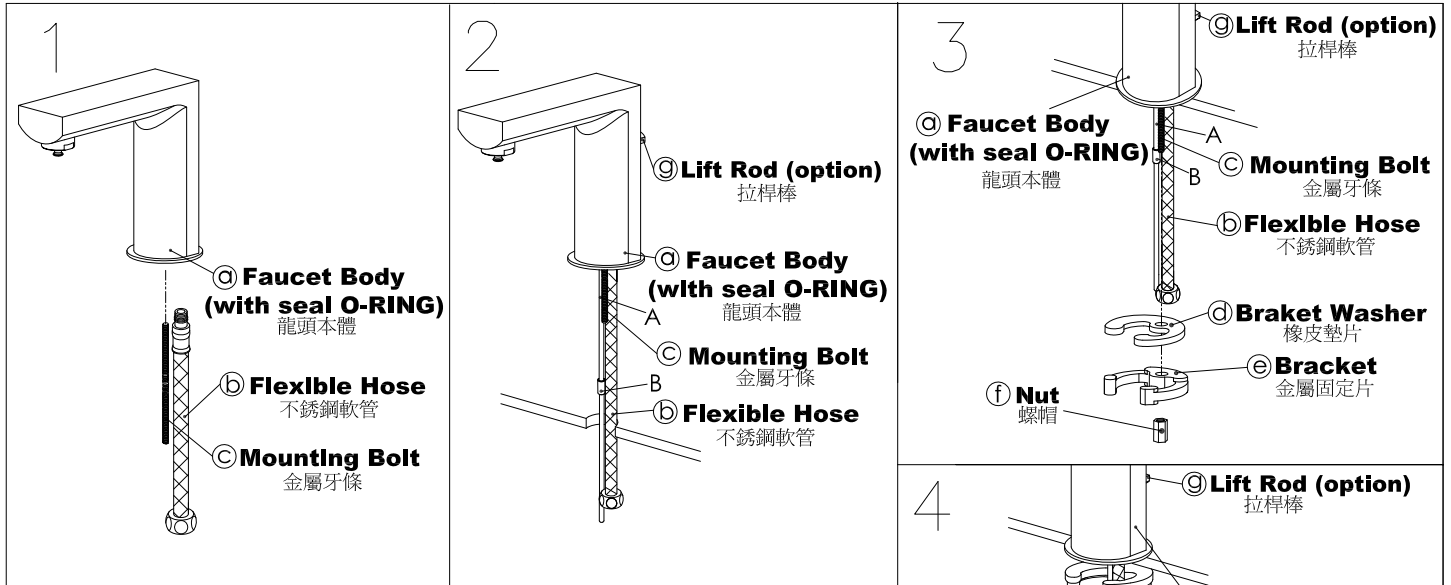

1. Screw Flexible Hoses and Mounting Bolt into Faucet Body (with seal O-RING).

將冷熱進水不銹鋼軟管和金屬牙條鎖緊固定於龍頭本體。

2. Insert Flexible Hoses and Mounting Bolt through basin hole in fixture, meanwhile, assemble Lift Rod with Faucet Body.

再將冷熱進水不銹鋼軟管和金屬牙條穿過洗臉盆(檯)洞口後,準備安裝,同時,把拉桿組裝在龍頭本體上。

3. Place Bracket (with Bracket Washer) and Nut onto Mounting Bolt, position faucet on fixture, then tighten Nut securely.

從金屬牙條下方依序套入橡皮墊片、金屬固定片、和螺帽,確認龍頭方向位置後,鎖緊螺帽固定龍頭即可。

4. Fix Tip-Touch Faucet first, then install Mechanical Mixing Valve on the hot and cold water supplies to the Tip-Touch Faucet shown as fig# 4

然後將按壓式檯面龍頭安裝固定,再將冷熱進水不銹鋼軟管和冷熱閥本體組合,並且鎖緊固定於按壓式龍頭本體下方。如圖 4。





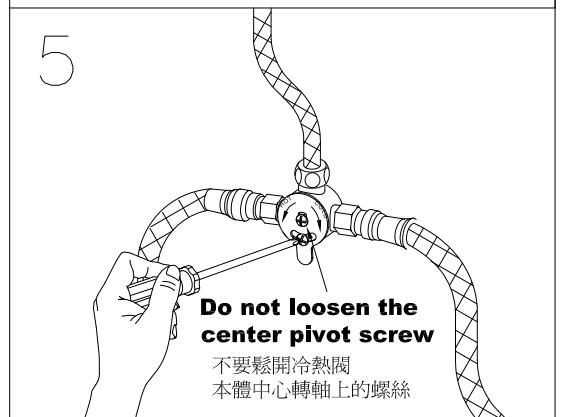
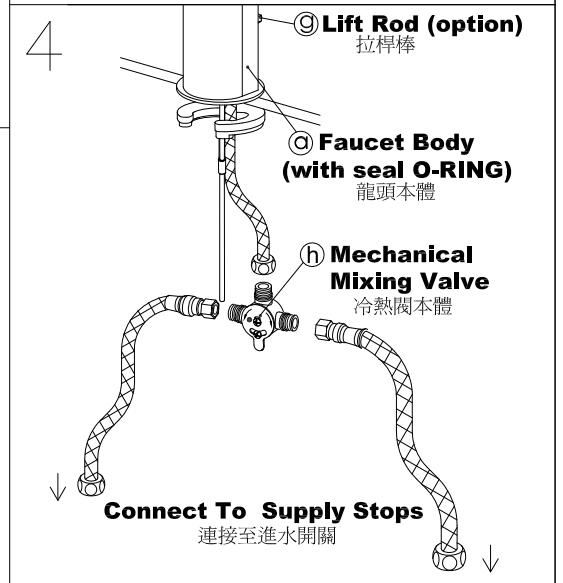
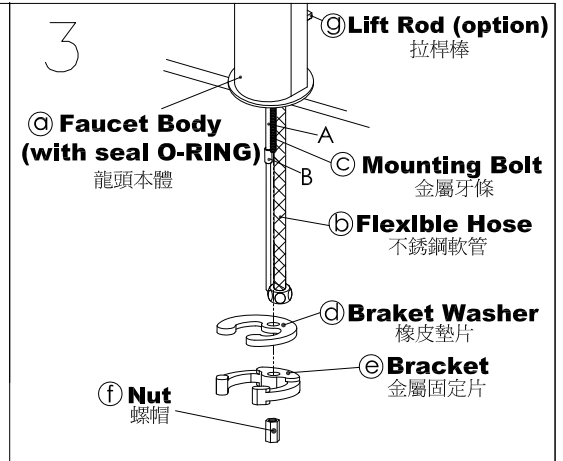

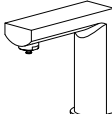

5. Loosen the Mechanical Mixing Valve dial plate lock-screw, adjust the proper water temperature as the direction of the arrows, then tighten the lock-screw to lock adjustment. (Caution: Do not attempt to loosen the center pivot screw.)

鬆開冷熱閥本體上調節溫度的螺絲,適當調整出水溫度,然後鎖緊螺絲,以完成溫度調節的功能。(警告:不要試圖鬆開冷熱閥本體中心轉軸上的螺絲。)

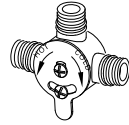

FIXING CONTENTS

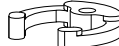
組配件內容

a) Faucet Body (with seal O-RING) 龍頭本體 	b) Flexible Hose 不銹鋼軟管  × 1  × 2	d) Bracket Washer × 1 橡皮墊片 	f) Nut × 1 螺帽 	h) Mechanical Mixing Valve × 1 冷熱閥本體 
	c) Mounting Bolt × 1 金屬牙條 	e) Bracket × 1 金屬固定片 	g) Lift Rod(option) 拉桿棒 A.  × 1 B.  × 1	