

## Towel Ladder 6817-17-81CP

### INTRODUCTION:

The main body had been designed with lovable elongate square shape, it demonstrate the neat esthetic sensibilities.



### DESCRIPTION:

- 1.Brass of sand-casting body meets JIS 3604 standard
- 2.Premium metal construction for durability
- 3.Justime finishes resist corrosion and tarnish
- 4.Finish meets the standard of ASTM-SC2
- 5.Correctly installed product's loading is 4 kg f
- 6.Coordinates with other products in Cubic Collection

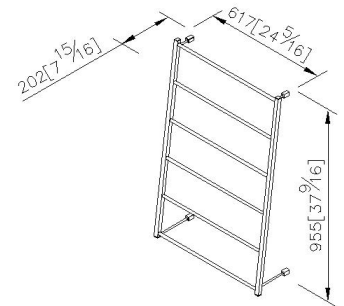

unit: mm[inch]

### Certificaion:

### Fixing Kits:

- 1.SUS 304 Stainless Steel Screws\*4
- Hex Key 1/8"\*1  
Plastic Anchors\*4  
Material of Wall Mount Bracket: Copper JIS3771\*2

### AWARD: