

Robe Hook
7801-50-80CP

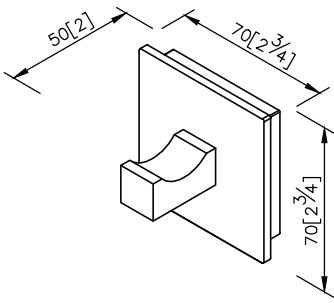

- 1.Brass of casting body meets JIS 3604 standard.
- 2.Premium metal construction for durability.
- 3.Justime finishes resist corrosion and tarnish.
- 4.Finish meets the standard of ASTM-SC2.
- 5.Correctly installed product's loading is 5 kgf.
- 6.Coordinates with other products in Happiness collection.

unit: mm[inch]

