

INSTALLATION INSTRUCTIONS

Three-Handle Valve

三把手嵌牆式閥體安裝說明

Applicable Product Number:

適用產品型號:

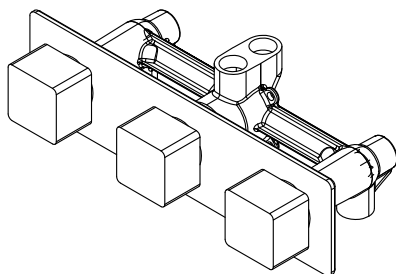

7909-Z0-81CP

7909-Z1-81CP

7909-Z2-81CP

7909-Z3-81CP

CARE & CLEANING

清潔與保養

CAUTION : This product might be damaged by improper installation, acid cleaning solution, misuse, improper care and cleaning.

1. Always follow the INSTALLATION INSTRUCTIONS provided and use extreme care while installing.
2. Do not use acid cleaning solution or abrasive cleaner (Ex: Hydrochloric acid or toothpaste); test your cleaning solution on an inconspicuous area before applying to the entire surface.
3. Wipe surfaces clean and rinse completely with water immediately after applying cleaner. Do not soak with cleaners. Rinse and dry any overspray that lands on nearby surfaces.
4. Use a dampened sponge or cloth to clean surface. (Do not use abrasive material such as brush or scouring pad.)

注意：此產品有可能因為不當安裝，誤用酸性清潔劑或清潔方式不正確而造成產品受損。

1. 產品安裝時必須依照產品所附的安裝說明和操作方式安裝。
2. 不可使用含有酸性或具研磨效果的清潔劑清洗（例如：鹽酸、牙膏），請先在產品較不顯眼的地方測試您的清潔方法，然後再應用到整個表面。
3. 產品塗佈清潔劑後，應立即擦拭除污，用清水沖洗，並擦乾產品和檯面。切勿讓清潔劑在產品表面浸濕潤漬過久。
4. 請使用濕海綿或乾淨棉布擦拭產品表面。（不可使用會刮傷或具研磨材質的刷子及鋼刷）。

FIXING CONTENTS

組配件內容

A. Valve Body X 1 (with sleeve)

牆壁內本體(含保護套筒)

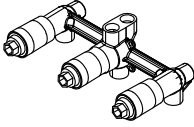

B. Divertor Handle X 1

切換器把手組

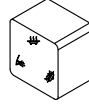

C. Handle (hot) X 1

熱水開關把手

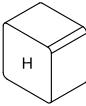

D. Handle (cold) X 1

冷水開關把手

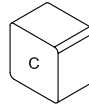

E. Retaining Nut X 3

固定螺帽



F. Plate X 1

面板

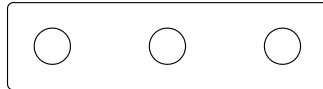

INSTALLATION NOTE

安裝注意事項

 **CAUTION : Please read the following point carefully before Installation.**

1. Keep the **Valve Body** faces horizontal and parallel to the wall that will be finished.
2. Connect hot and cold supplies pipes to the valve body, so they are between 2"(5cm) minimum and 3"(7.6cm) maximum from the finished wall; or keep the distance be 0.4" (1.1cm) to 1.5" (3.7cm) between top of cartridge and **Finished Wall** for necessary conditions.

 **CAUTION : Risk of product damage.**

1. When finished installation, turn the valve on and run water for 1 minute to remove any debris before using.

 注意：安裝前，請詳閱下列注意事項。

1. 本產品安裝固定閥體於牆壁內側時，閥體需與牆壁保持平行。
2. 進水管中心與最終完成牆面的距離須保持在最小2"(5cm)到最大3"(7.6cm)之間，或陶瓷中心栓與最終完成牆面保持在最小0.4"(1.1cm)到最大1.5"(3.7cm)。

 注意：為增加產品使用壽命，請依說明清潔供水管路。

1. 完成安裝後，需在使用前先把供水開關全開排水持續一分鐘，去除雜質，以保持管路清潔。

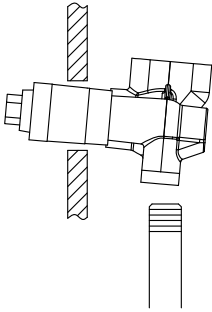

Finished Wall
最終完成牆面

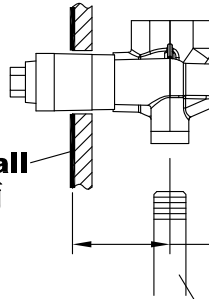

2"(5cm)MIN
3"(7.6cm)MAX

Water supplier
進水端

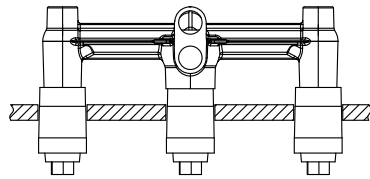
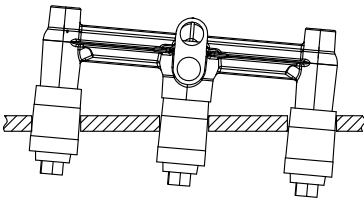

INSTALLATION INSTRUCTIONS

安裝說明

1

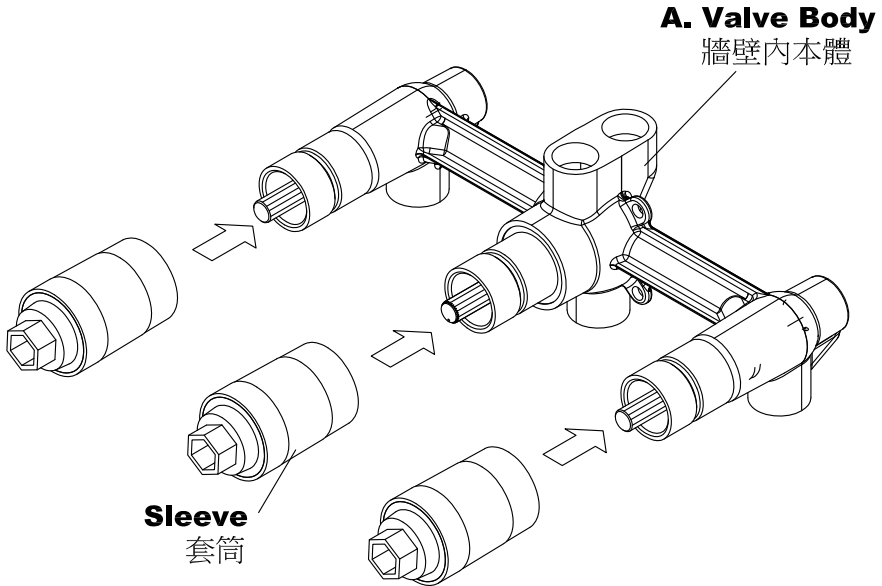

* Use **Sleeves** to protect the cartridge and thread before installation.
使用套筒保護陶瓷中心栓及螺牙，必須在安裝程序前先套上。

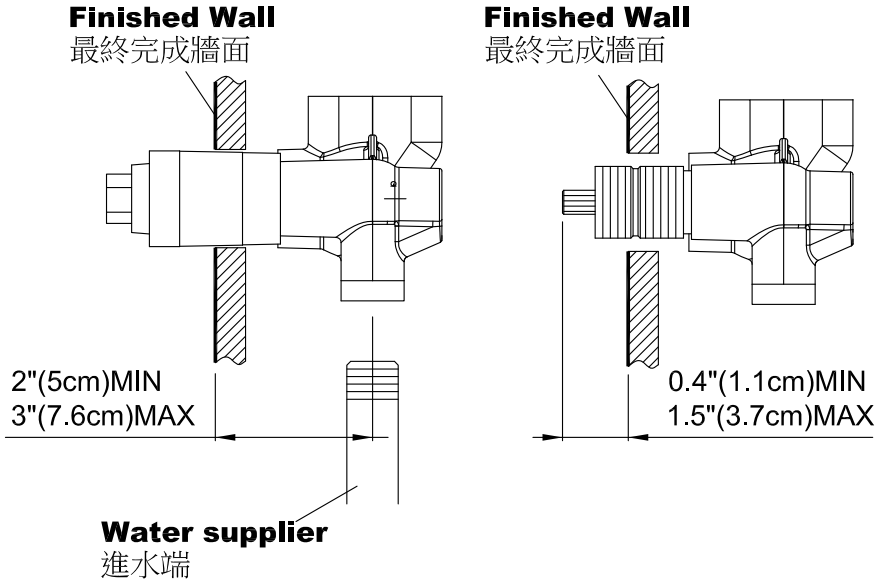

- * Connect hot and cold supplies pipes to the valve body, so they are between 2"(5cm) minimum and 3"(7.6cm) maximum from the finished wall; or keep the distance be 0.4" (1.1cm) to 1.5" (3.7cm) between top of cartridge and **Finished Wall** for necessary conditions.

安裝牆壁內本體時需預留的牆壁厚度，牆壁內本體與最終完成牆面的距離須保持在最小2"(5cm)到最大3"(7.6cm)之間，或陶瓷中心栓與最終完成牆面保持在最小0.4"(1.1cm)到最大1.5"(3.7cm)，此為安裝必要條件。

3

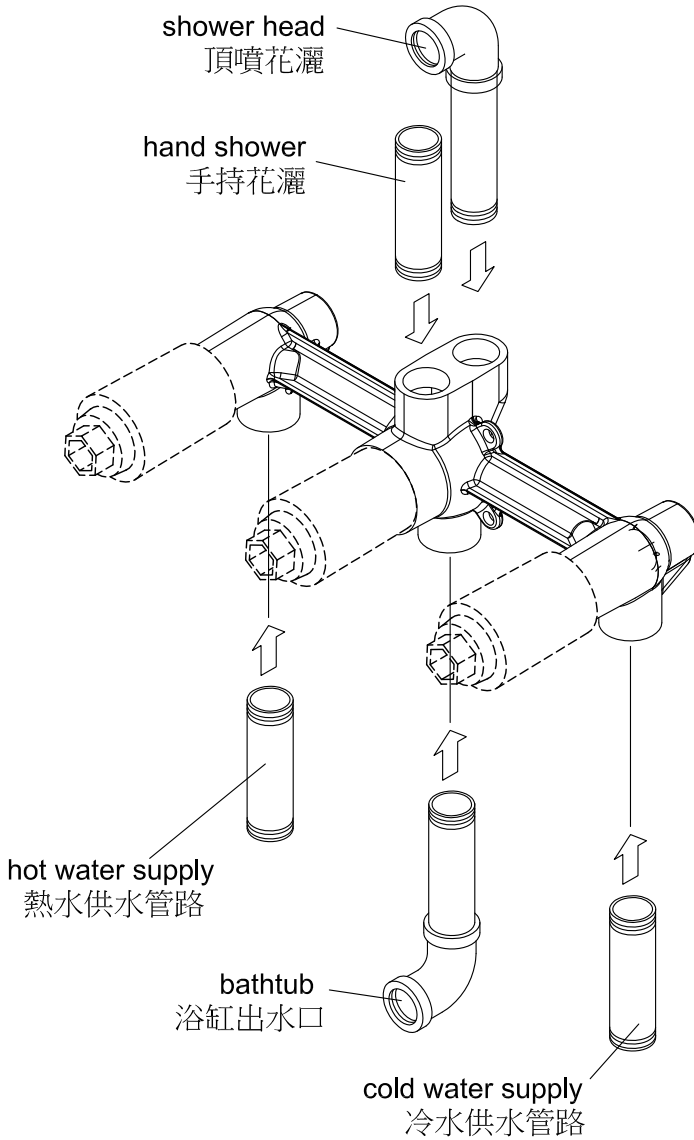

* Install hot and cold water supply pipes and outlet.

依圖示，安裝冷熱供水管路，與出水管路。

4

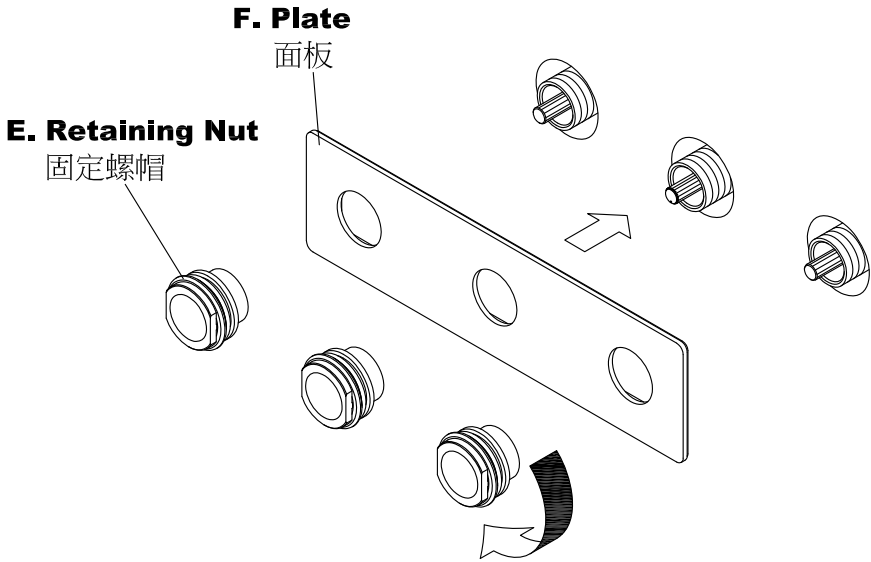

* Fix the **Plate** against wall with **Retaining Nut**.
取固定螺帽將面板完全固定且貼合牆壁。

5

Point mark stop at six o'clock position.

記號點朝6點鐘方向

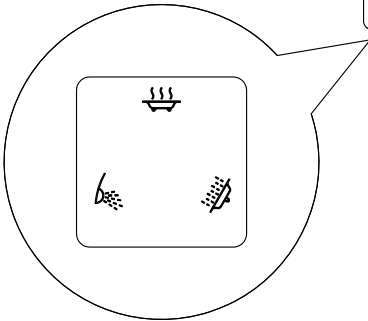
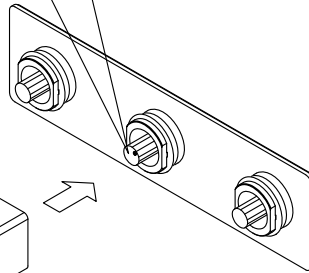
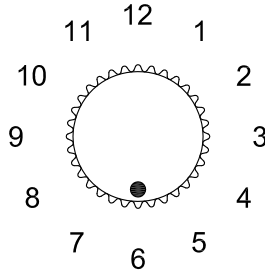

B. Divertor Handle

切換器把手組

* Keep the Mixer Valve straight ahead of you, then turning the **Divertor Spindle** until the Point mark stop at six o'clock position. Press **Divertor Handle** onto valve spindle until heard a click sound.

面對切換器中心栓，轉動中心栓，使記號點朝向6點鐘方向。將切換器把手依圖示方向組入中心栓，壓到底之後會有喀噠聲，表示安裝完成。

6

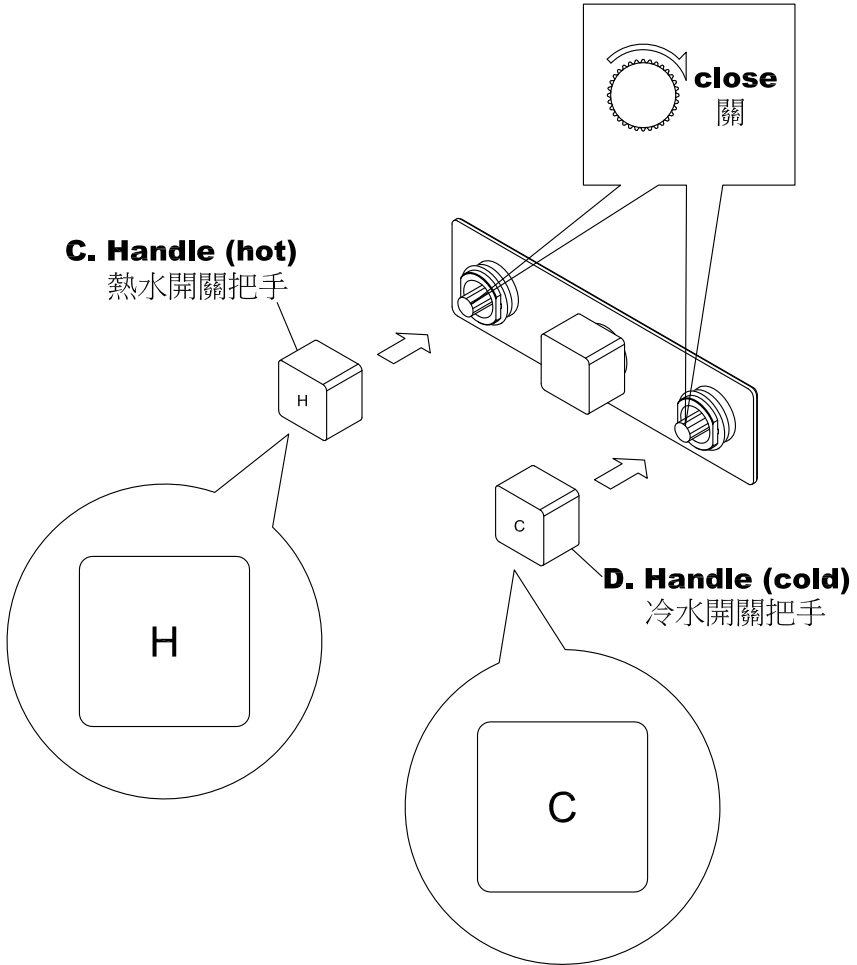

* Turn **Hot Valve** and **Cold Valve** clockwise to closed position before install the **Handle**. Press both hot and cold **Handle** onto valve spindle until heard a click sound.

先將冷熱水開關順時鐘轉至關水位置。將把手依圖示方向組入中心栓，壓到底之後會有喀噠聲，表示安裝完成。

WARRANTY

Sheng Tai Co., Ltd. offer a three-year warranty on all of the Faucets & Bathroom Accessories from date of purchasing. The warranty covers any defect in material and workmanship during normal residential use. The following conditions of defect are charged for maintaining.

- Damage caused by accident, misuse, improper care and cleaning.
- Improper using or installation.
- Defects because of the external factors, such as erodent environment (ex. Seashore or mineral spring.), animal bites or dead body remains in product etc.
- Defect because of sand or impurity stuck in faucet water way.
- Using water not adhered to the regulations of national standard.
- Deficiency caused by freeze.
- Not showing this warranty card.
- Not filling out in the blank of name of customer, date of purchase, cost of purchase, company of installation (retail store) and stamp on warranty card.
- Sheng Tai Co., Ltd. is not responsible for labor charges, installation, or other incidental or consequential costs.

勝泰衛材股份有限公司提供所有的水龍頭及浴室配件，從購買之日起三年保固。保固範圍包括在一般住宅正常使用的期間，發現產品有任何材質和加工上的瑕疵。如瑕疵有下列情形，將收取維修費用。

- 因意外事故、不當操作使用，不當的保養維護和清洗所造成的損害。
- 不當使用或安裝。
- 外在因素造成產品的瑕疵，如易造成侵蝕的環境（如濱海或溫泉地區）、動物嚙咬或屍體存在於產品內造成的損壞。
- 因砂子或雜質卡住水龍頭水路造成的損壞。
- 沒有依循國家標準的規定使用水源造成的損壞。
- 因冰凍造成的水量不足。
- 未出示此保固卡。
- 未在空白處填寫客戶名稱，購買日期，購買成本，安裝公司（零售商店），及保證卡上未蓋章。
- 勝泰衛材股份有限公司不負責工人費用，安裝，或其他附帶或間接產生的費用。

Customer	Name		Tel	
	Address			
Product	Serial No.		Name	
	Warranty	Three year from date of purchase.		
Purchase place	Store		Tel	
	Address			
Purchase Date				
Purchase Price				

JUSTIME
www.justime.com

SHENG TAI BRASSWARE CO., LTD.

No.99 Sec.3 Chang Tsao Rd. Ho Me, Chang Hua, Taiwan

508 台灣彰化縣和美鎮彰草路3段99號

TEL: +886-4-7629971~4

FAX: +886-4-7526980

E-mail: shengtai@ms10.hinet.net

Facebook: www.facebook.com/JUSTIME